



WB1S Module Datasheet

Device Development > Cloud Module > WiFi&BT Dual Mode Module

Version: 20200718

Contents

1	Product Overview	1
1.1	Features	1
1.2	Applications	1
2	Change History	3
3	Module Interfaces	4
3.1	Dimensions and Footprint	4
3.2	Interface Pin Definition	4
3.3	Test Pin Definition	8
4	Electrical Parameters	11
4.1	Absolute Electrical Parameters	11
4.2	Electrical Conditions	11
4.3	RF Current Consumption	12
4.4	Working Current	13
5	RF Features	15
5.1	Basic RF Features	15
5.2	TX Performance	15
5.3	RX Performance	16
6	Antenna Information	18
6.1	Antenna Type	18
6.2	Antenna Interference Reduction	18
6.3	Antenna Connector Specifications	19
7	Packaging Information and Production Instructions	20
7.1	Mechanical Dimensions	20
7.2	Recommended PCB Layout	21
7.3	Production Instructions	21
7.4	Recommended Oven Temperature Curve	23
7.5	Storage Conditions	24
8	MOQ and Packaging Information	26

9 Appendix—Statement

27

1 Product Overview

WB1S is a low-power embedded Wi-Fi+BLE Dual protocol module that Tuya has developed. It consists of a highly integrated RF chip (BK7231T) and several peripheral components, with an embedded Wi-Fi network protocol stack and robust library functions. WB1S also contains a low-power 32-bit microcontroller unit (MCU), 1T1R WLAN module, 256 KB static random-access memory (SRAM), 2 MB flash memory, and extensive peripherals. WB1S is an RTOS platform that integrates all function libraries of the Wi-Fi MAC and TCP/IP protocols. You can develop embedded Wi-Fi products as required.

1.1 Features

- Embedded low-power 32-bit CPU, which can also function as an application processor
- Clock rate: 120 MHz
- Working voltage: 3.0 V to 3.6 V
- Peripherals: nine GPIOs, one universal asynchronous receiver/transmitter (UART), and one analog-to-digital converter (ADC)
- Wi-Fi connectivity
- 802.11b/g/n
- Channels 1 to 14 at 2.4 GHz
- WPA and WPA2 security modes
- Up to +16 dBm output power in 802.11b mode
- EZ net pairing mode for Android and iOS devices
- On-board PCB antenna
- Working temperature: -20°C to +85°C
- BLE \ Support Bluetooth (V4.0) \ Maximum output power + 6dBm \ On-board PCB antenna and external antenna IPEX connector

1.2 Applications

- Intelligent building
- Smart household and home appliances
- Smart socket and light
- Industrial wireless control

- Baby monitor
- Network camera
- ntelligent bus

2 Change History

No.	Date	Change Description	Version After Change
1	2019-11-22	This is the first release.	1.0.0

3 Module Interfaces

3.1 Dimensions and Footprint

WB1S has two rows of pins with a 2 mm pin spacing. The WB1S dimensions (H x W x L) are 2.8 mm x 16 mm x 23.5 mm. Note: The default dimensional tolerance is ± 0.35 mm. If a customer has other requirements, clearly specify them in the datasheet after communication. \

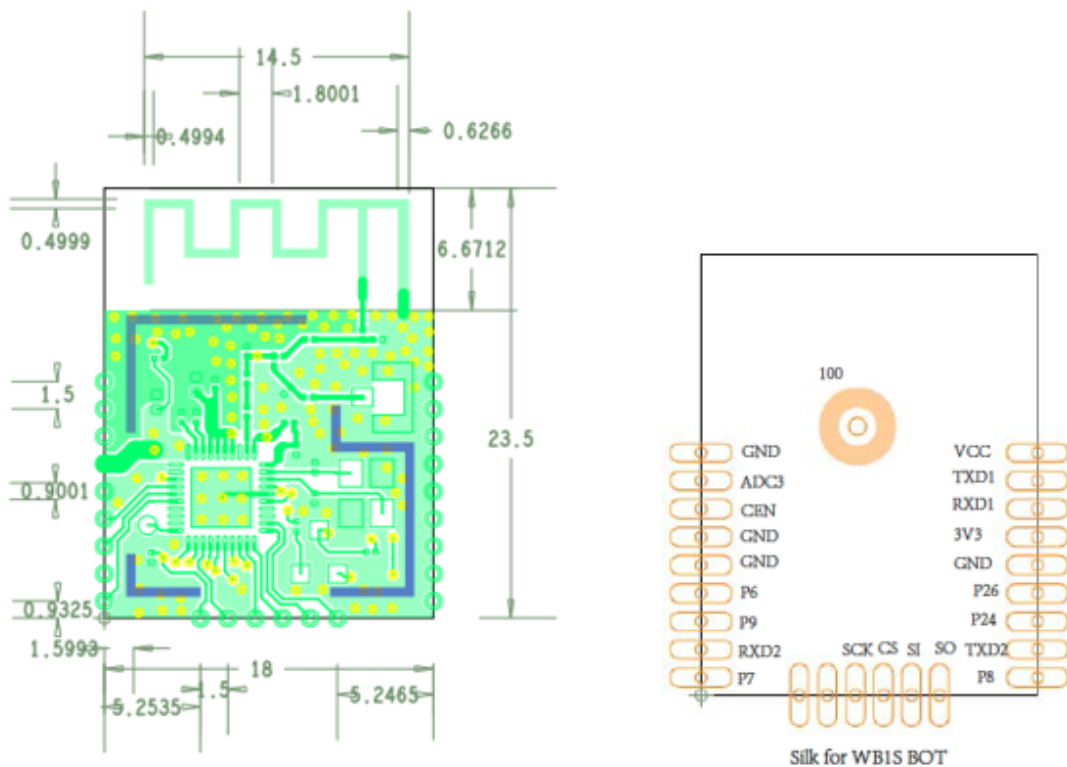

3.2 Interface Pin Definition

Pin No.	Symbol	I/O Type	Function
1	VCC	P	Power supply pin (3.3 V)

Pin No.	Symbol	I/O Type	Function
2	TXD1	I/O	UART1_TXD, which is used as a user-side serial interface pin and connected to the P11 pin on the internal IC
3	RXD1	I/O	UART1_RXD, which is used as a user-side serial interface pin and connected to the P10 pin on the internal IC
4	3V3	P	Power supply pin (3.3 V)
5	GND	P	Power supply reference ground pin
6	P26	I/O	Common I/O pin, which can be used as a hardware PWM pin and is connected to the P26 pin on the internal IC

Pin No.	Symbol	I/O Type	Function
7	P24	I/O	Common I/O pin, which can be used as a hardware PWM pin and is connected to the P24 pin on the internal IC
8	TXD2	I/O	UART2_TXD, which is used for displaying the module internal information and is connected to the P0 pin on the internal IC
9	P8	I/O	Common I/O pin, which can be used as a hardware PWM pin and is connected to the P8 pin on the internal IC
10	P7	I/O	Common I/O pin, which can be used as a hardware PWM pin and is connected to the P7 pin on the internal IC

Pin No.	Symbol	I/O Type	Function
11	RXD2	I/O	UART0_RXD, which is used for displaying the module internal information and is connected to the P1 pin on the internal IC
12	P9	I/O	Common I/O pin, which can be used as a hardware PWM pin and is connected to the P9 pin on the internal IC
13	P6	I/O	Common I/O pin, which can be used as a hardware PWM pin and is connected to the P6 pin on the internal IC
14	GND	P	Power supply reference ground pin
15	GND	P	Power supply reference ground pin

Pin No.	Symbol	I/O Type	Function
16	CEN	I	Low-level reset, high-level active (internally pulled high) Docking IC-CEN
17	ADC3	AI	ADC pin, which is connected to the P23 pin on the internal IC
18	GND	P	Power supply reference ground pin

Note:

- P indicates power supply pins, I/O indicates input/output pins, and AI indicates analog input pins.
- CEN is only a hardware reset pin and cannot clear the Wi-Fi network configuration.

3.3 Test Pin Definition

Pin No.	Symbol	I/O Type	Function
1	SO	I/O	Data output pin when data is downloaded from the flash memory, which is used for module production and firmware burning and is connected to the P23 or ADC3 pin on the internal IC
2	SI	I/O	Data input pin when data is downloaded from the flash memory, which is used for module production and firmware burning and is connected to the P22 pin on the internal IC
3	CS	I/O	Chip selection pin when data is downloaded from the flash memory, which is used for module production and firmware burning and is connected to the P21 pin on the internal IC

Pin No.	Symbol	I/O Type	Function
4	SCK	I/O	Clock pin when data is downloaded from the flash memory, which is used for module production and firmware burning and is connected to the P20 pin on the internal IC

Note:

- Test pins are not recommended.

4 Electrical Parameters

4.1 Absolute Electrical Parameters

Parameter	Description	Minimum Value	Maximum Value	Unit
Ts	Storage temperature	-40	150	°C
VCC	Power supply voltage	-0.3	3.6	V
Static electricity voltage (human body model)	Tamb = 25°C	N/A	2	kV
Static electricity voltage (machine model)	Tamb = 25°C	N/A	0.5	kV

4.2 Electrical Conditions

Parameter	Description	Minimum Value	Typical Value	Maximum Value	Unit
Ta	Working temperature	-20	N/A	85	°C
VCC	Power supply voltage	3.0	3.3	3.6	V

Parameter	Description	Minimum Value	Typical Value	Maximum Value	Unit
V_{IL}	I/O low-level input	-0.3	N/A	$VCC \times 0.25$	V
V_{IH}	I/O high-level input	$VCC \times 0.75$	N/A	3.6	V
V_{OL}	I/O low-level output	N/A	N/A	$VCC \times 0.1$	V
V_{OH}	I/O high-level output	$VCC \times 0.8$	N/A	VCC	V
I_{max}	I/O drive current	N/A	6	15	mA

4.3 RF Current Consumption

Working Status	Mode	Rate	TX Power / Receiving	Typical Value	Unit
TX	802.11b	11 Mbit/s	+16 dBm	222	mA
	802.11g	54 Mbit/s	+14 dBm	195	mA
	802.11n	MCS7	+12 dBm	185	mA
	802.11n HT40	MCS7	+12 dBm	190	mA
RX	802.11b	11 Mbit/s	Constant receiving	98	mA
	802.11g	54 Mbit/s	Constant receiving	98	mA

Working Status	Mode	Rate	TX Power / Receiving	Typical Value	Unit
	802.11n	MCS7	Constant receiving	98	mA
	802.11n HT40	MCS7	Constant receiving	116	mA

4.4 Working Current

Working Mode	Working Status (Ta = 25°C)	Average Value	Peak Value ^{^^} (Typical Value)	Unit
Quick connection network status (Bluetooth network)	The module is in the fast network configuration state, and the WIFI indicator flashes quickly	100	260	mA
Fast connection network status (AP network configuration)	The module is in the fast connection network configuration state, the WIFI indicator flashes slowly	80	360	mA

Working Mode	Working Status (Ta = 25°C)	Average Value	Peak Value ^{^^} (Typical Value)	Unit
Quick Connect Network Status (EZ Network)	The module is in the fast network configuration state, and the WIFI indicator flashes quickly	80	320	mA
Network connection idle state	The module is connected to the network and the WiFi indicator is always on	50	250	mA
Network connection operation status	The module is connected to the network and the WiFi indicator is always on	60	260	mA
Disconnected status	Module is offline	105	250	mA

5 RF Features

5.1 Basic RF Features

Parameter	Description
Frequency band	2.412 GHz to 2.484 GHz
Wi-Fi standard	IEEE 802.11b/g/n (channels 1 to 14)
BLE standard	BLE 4.0
Data transmission rate	802.11b: 1, 2, 5.5, or 11 (Mbit/s)
	802.11g: 6, 9, 12, 18, 24, 36, 48, or 54 (Mbit/s)
	802.11n: HT20 MCS0 to MCS7
	802.11n: HT40 MCS0 to MCS7
Antenna type	Onboard PCB antenna with a gain of 0.5 dBi

5.2 TX Performance

Parameter	Minimum Value	Typical Value	Maximum Value	Unit
Average RF output power, 802.11b CCK mode 11 Mbit/s	N/A	16	N/A	dBm
Average RF output power, 802.11g OFDM mode 54 Mbit/s	N/A	14	N/A	dBm

Parameter	Minimum Value	Typical Value	Maximum Value	Unit
Average RF output power, 802.11n OFDM mode MCS7	N/A	13	N/A	dBm
Frequency error	-2	N/A	+2	ppm
EVM under 802.11b CCK, 11 Mbit/s 16 dBm		-18		dB
EVM under 802.11g OFDM, 54 Mbit/s, 14 dBm	-30	-29	-25	dB
EVM under 802.11n OFDM, MCS7, 13 dBm	-31	-28	-27	dB

5.3 RX Performance

Parameter	Minimum Value	Typical Value	Maximum Value	Unit
PER < 8%, 802.11b CCK mode 1 Mbit/s	N/A	-92	N/A	dBm
PER < 10%, 802.11g OFDM mode 54 Mbit/s	N/A	-75	N/A	dBm

Parameter	Minimum Value	Typical Value	Maximum Value	Unit
PER < 10%, 802.11n OFDM mode MCS7	N/A	-68	N/A	dBm
PER < 10%,BLE 1M	NA	-95	NA	dBm

6 Antenna Information

6.1 Antenna Type

The default method is a PCB onboard antenna

6.2 Antenna Interference Reduction

To ensure optimal Wi-Fi performance when the Wi-Fi module uses an onboard PCB antenna, it is recommended that the antenna be at least 15 mm away from other metal parts. To prevent adverse impact on the antenna radiation performance, avoid copper or traces along the antenna area on the PCB. Deploy the antenna based on the antenna placement solutions, as shown in the following figure \

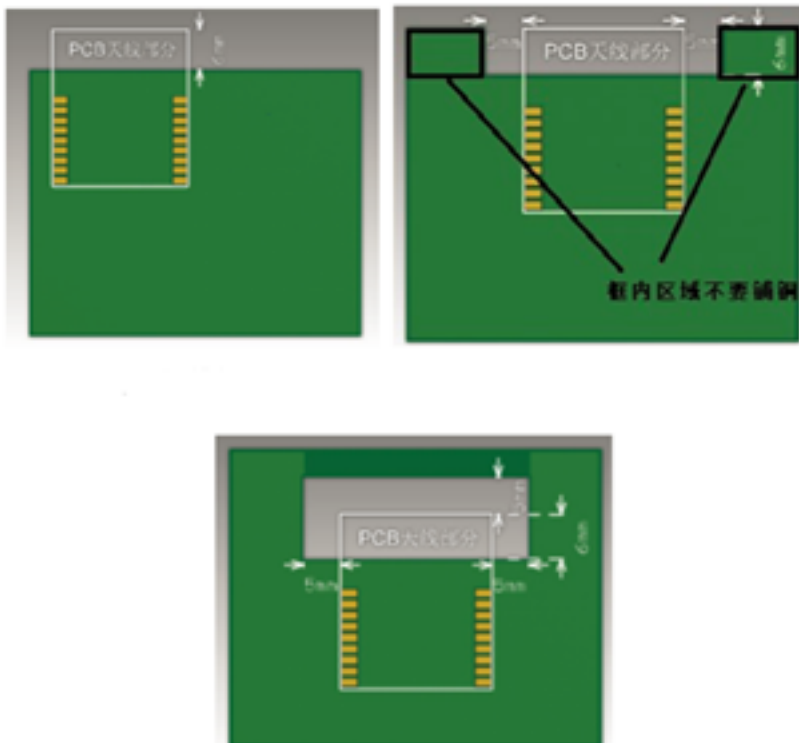

6.3 Antenna Connector Specifications

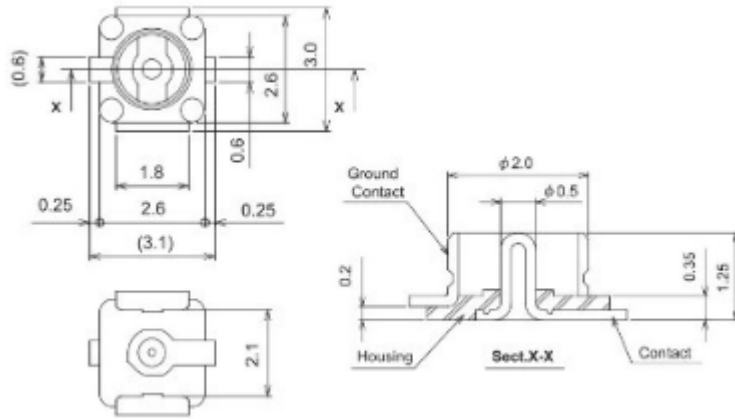

7 Packaging Information and Production Instructions

7.1 Mechanical Dimensions

\

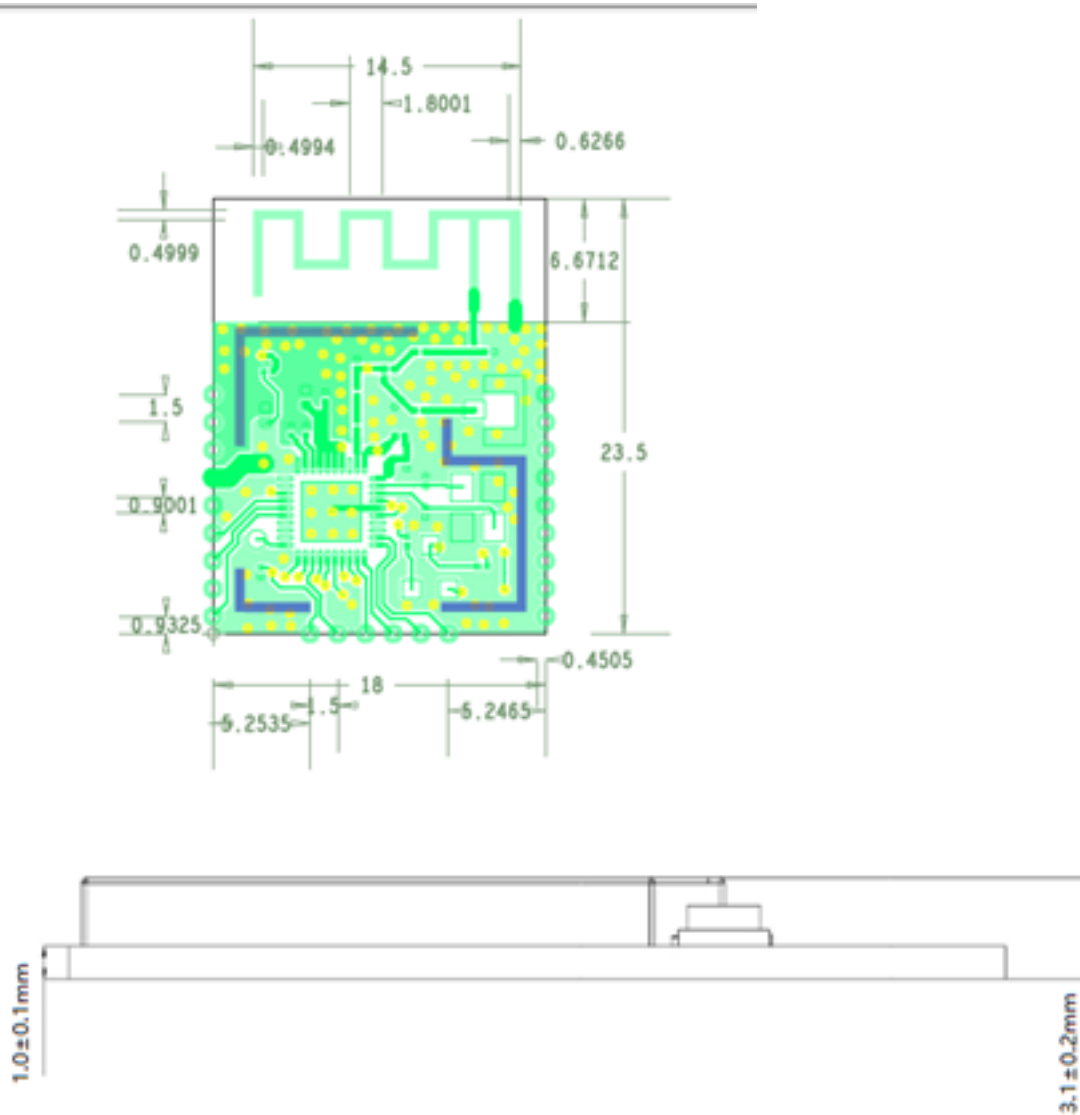

\ Note: The default dimensional tolerance is $\pm 0.35 \text{ mm}$. If a customer has other requirements, clearly specify them in the datasheet after communication.

7.2 Recommended PCB Layout

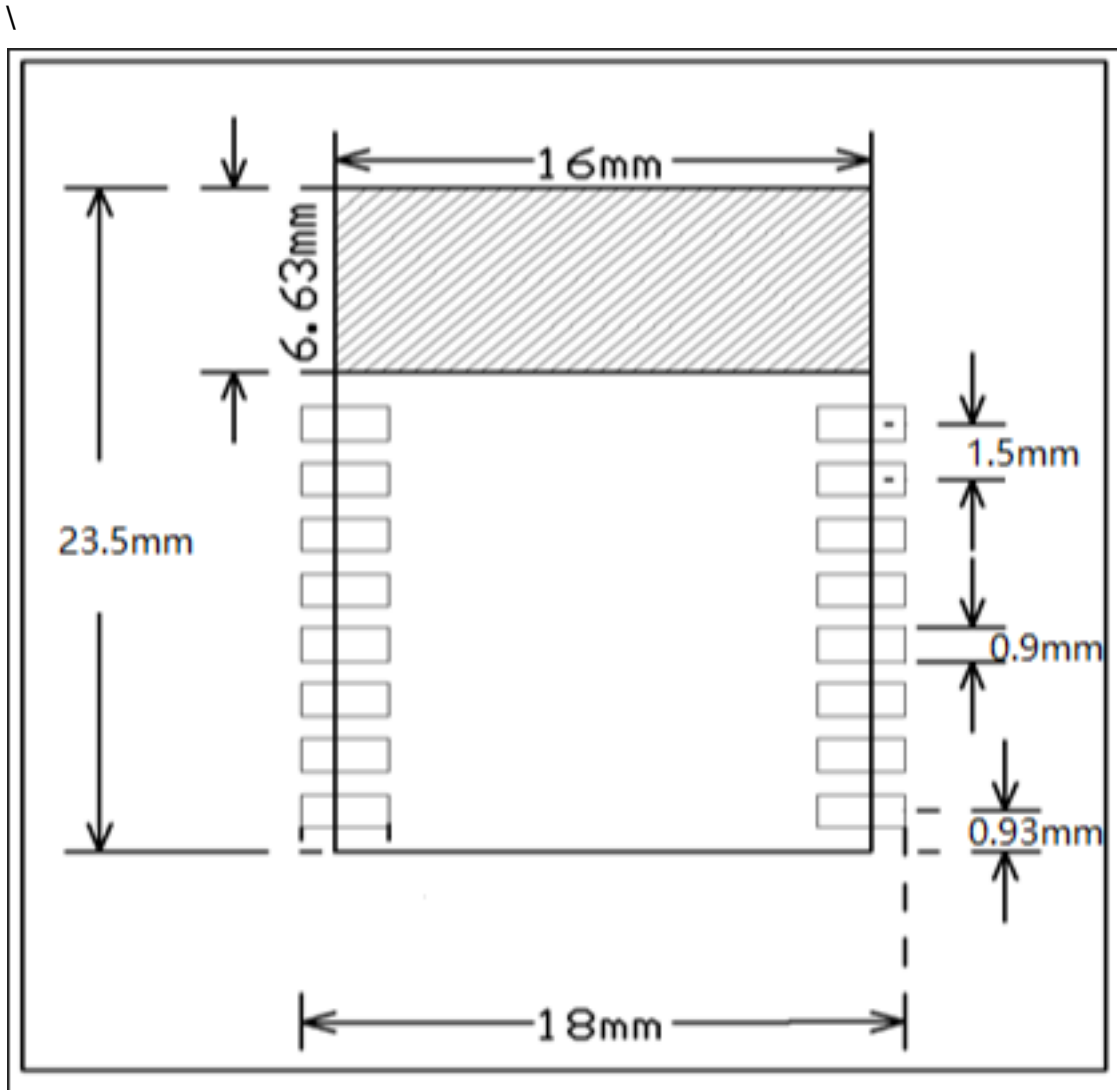

\ Note: The default dimensional tolerance is ± 0.35 mm. If a customer has other requirements, clearly specify them in the datasheet after communication.

7.3 Production Instructions

1. Use an SMT placement machine to mount the stamp hole module that Tuya produces onto the PCB within 24 hours after the module is unpacked and the firmware is burned. If not, vacuum pack the module again. Bake the module before mounting it onto the PCB.

- (1) SMT placement equipment
 - i. Reflow soldering machine
 - ii. Automated optical inspection (AOI) equipment
 - iii. Nozzle with a 6 mm to 8 mm diameter
 - (2) Baking equipment
 - i. Cabinet oven
 - ii. Anti-static heat-resistant trays
 - iii. Anti-static heat-resistant gloves
2. Storage conditions for a delivered module are as follows:
- (1) The moisture-proof bag is placed in an environment where the temperature is below 30°C and the relative humidity is lower than 85%.
 - (2) The shelf life of a dry-packaged product is 12 months from the date when the product is packaged and sealed.
 - (3) The package contains a humidity indicator card (HIC).

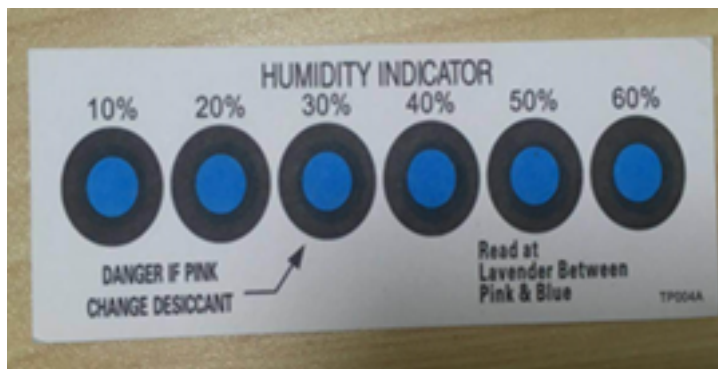

3. Bake a module based on HIC status as follows when you unpack the module package:
- (1) If the 30%, 40%, and 50% circles are blue, bake the module for 2 consecutive hours.
 - (2) If the 30% circle is pink, bake the module for 4 consecutive hours.
 - (3) If the 30% and 40% circles are pink, bake the module for 6 consecutive hours.
 - (4) If the 30%, 40%, and 50% circles are pink, bake the module for 12 consecutive hours.
4. Baking settings:

- (1) Baking temperature: $125\pm 5^{\circ}\text{C}$
 - (2) Alarm temperature: 130°C
 - (3) SMT placement ready temperature after natural cooling: $< 36^{\circ}\text{C}$
 - (4) Number of drying times: 1
 - (5) Rebaking condition: The module is not soldered within 12 hours after baking.
5. Do not use SMT to process modules that have been unpacked for over three months. Electroless nickel immersion gold (ENIG) is used for the PCBs. If the solder pads are exposed to the air for over three months, they will be oxidized severely and dry joints or solder skips may occur. Tuya is not liable for such problems and consequences.
 6. Before SMT placement, take electrostatic discharge (ESD) protective measures.
 7. To reduce the reflow defect rate, draw 10% of the products for visual inspection and AOI before first SMT placement to determine a proper oven temperature and component placement method. Draw 5 to 10 modules every hour from subsequent batches for visual inspection and AOI.

7.4 Recommended Oven Temperature Curve

Perform SMT placement based on the following reflow oven temperature curve. The highest temperature is 245°C . \

Temperature Setting (°C)										
Temperature Zone	1	2	3	4	5	6	7	8	9	10
Upper Temperature Zone	100	130	160	170	180	180	200	225	250	250
Lower Temperature Zone	100	130	160	170	180	180	200	225	250	250
Conveyor Belt Speed (cm/minute)	75.0									

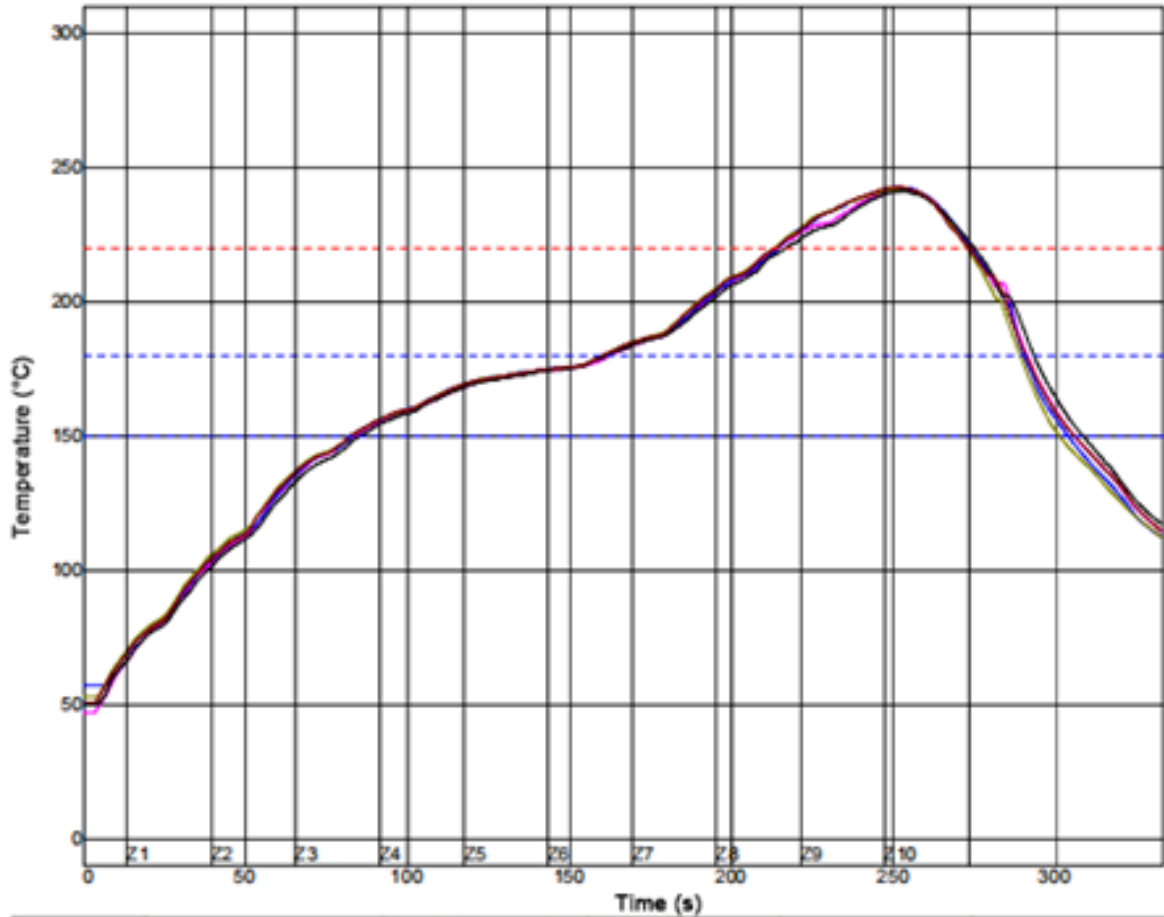

PWI 58%	Maximum Negative Slope	Constant Temperature Time (150°C to 180°C)	Return Time/220°C	Highest Temperature	Slope 1 (100°C to 150°C)					
<TC2>	-2.44	4%	78.45	-44%	59.68	-35%	242.34	22%	1.38	-8%
<TC3>	-2.49	1%	77.28	-51%	59.79	-35%	242.90	32%	1.34	-11%
<TC4>	-2.55	-4%	77.48	-50%	59.84	-34%	242.28	21%	1.32	-12%
<TC5>	-2.26	16%	76.31	-58%	58.52	-43%	241.88	10%	1.32	-12%
<TC6>	-2.37	8%	77.87	-48%	59.89	-34%	243.12	36%	1.38	-8%
總數	0.29	2.14					1.54			0.06

7.5 Storage Conditions

\



CAUTION
This bag contains
MOISTURE-SENSITIVE DEVICES

LEVEL
3

if Blank, see adjacent bar code label

1. Calculated shelf life in sealed bag: 12 months at < 40°C and < 90% relative humidity (RH)
2. Peak package body temperature: 260 °C
if Blank, see adjacent bar code label
3. After bag is opened, devices that will be subjected to reflow solder or other high temperature process must
 - a) Mounted within: 168 hrs. of factory conditions
if Blank, see adjacent bar code label
 ≤ 30°C/60%RH, OR
 - b) Stored at <10% RH
4. Devices require bake, before mounting, if:
 - a) Humidity Indicator Card is > 10% when read at 23 ± 5°C
 - b) 3a or 3b not met.
5. If baking is required, devices may be baked for 48 hrs. at 125 ± 5°C

Note: If device containers cannot be subjected to high temperature or shorter bake times are desired, reference IPC/JEDEC J-STD-033 for bake procedure

Bag Seal Date: _____
if Blank, see adjacent bar code label

Note: Level and body temperature defined by IPC/JEDEC J-STD-020

8 MOQ and Packaging Information

Product number	MOQ (pcs)	Shipping packaging method	Modules per reel (pcs)	Packaging reels per box (reels)
WB1S	4000	Tape reel	1000	4

9 Appendix—Statement

Federal Communications Commission (FCC) Declaration of Conformity FCC Caution: Any changes or modifications not expressly approved by the party responsible for compliance could void the user's authority to operate this equipment. This device complies with Part 15 of the FCC Rules. Operation is subject to the following two conditions: (1) This device may not cause harmful interference, and (2) this device must accept any interference received, including interference that may cause undesired operation. This device and its antenna(s) must not be co-located or operating in conjunction with any other antenna or transmitter. 15.105 Information to the user. (b) For a Class B digital device or peripheral, the instructions furnished the user shall include the following or similar statement, placed in a prominent location in the text of the manual: Note: This equipment has been tested and found to comply with the limits for a Class B digital device, pursuant to part 15 of the FCC Rules. These limits are designed to provide reasonable protection against harmful interference in a residential installation. This equipment generates, uses and can radiate radio frequency energy and, if not installed and used in accordance with the instructions, may cause harmful interference to radio communications. However, there is no guarantee that interference will not occur in a particular installation. If this equipment does cause harmful interference to radio or television reception, which can be determined by turning the equipment off and on, the user is encouraged to try to correct the interference by one or more of the following measures: —Reorient or relocate the receiving antenna. —Increase the separation between the equipment and receiver. —Connect the equipment into an outlet on a circuit different from that to which the receiver is connected. —Consult the dealer or an experienced radio/TV technician for help.

This equipment complies with FCC radiation exposure limits set forth for an uncontrolled environment. This equipment should be installed and operated with minimum distance 20 cm between the radiator and your body.

Radiation Exposure Statement: This equipment complies with FCC radiation exposure limits set forth for an uncontrolled environment. This transmitter must not be co-located or operating in conjunction with any other antenna or transmitter. The availability of some specific channels and/or operational frequency bands is country dependent and firmware programmed at the factory to match the intended destination. The firmware setting is not accessible by the end user.

The final end product must be labeled in a visible area with the following: "Con-

tains Transmitter Module2AFNL-BR3L” This radio module must not be installed to co-locate and operating simultaneously with other radios in host system, additional testing and equipment authorization may be required to operating simultaneously with other radio.

This LMA does not have RF shielding and is tested and approved as standalone configuration, additional evaluation may be required for any system integrated this radio module.

Declaration of Conformity European notice \



Hereby, Hangzhou Tuya Information Technology Co., Ltd. declares that this Wi-Fi module product is in compliance with essential requirements and other relevant provisions of Directive 2014/53/EC. A copy of the Declaration of conformity can be found at <https://www.tuya.com>.

EN 300 328 V2.1.1

EN 301 489-1 V2.1.1; EN 301 489-17 V3.1.1

EN 62311:2008

EN 60950-1:2006+A11:2009+A1:2010+A12:2011+A2:2013